



ABOUT

SCANIA has proven to be a great success for SMG Engineering Automotive Company particularly with the recent growth in the construction sector. SMG with SCANIA, aim to provide the best configuration that would deliver the highest profitability for its customers.

SCANIA Egypt through its triple S branch, dedicated management, and after sales support operation, continues to grow in volumes and provide best in class customer satisfaction.

Scania is able through its engineers to turn services into solutions; while delighting our customers with a unique experience at our service center.

PRODUCTS

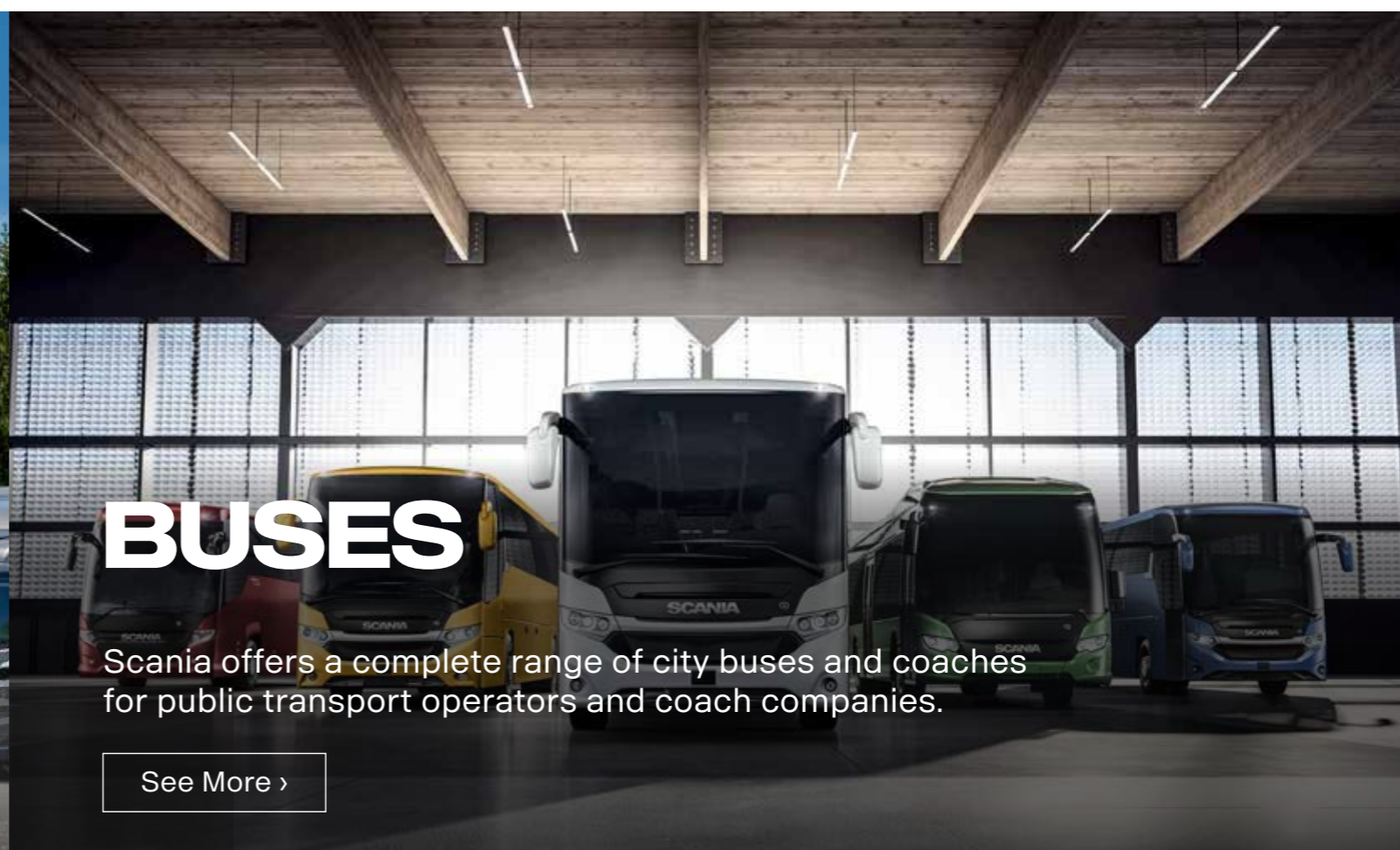

EXAMPLE OF OUR CLIENTS



GALLERY

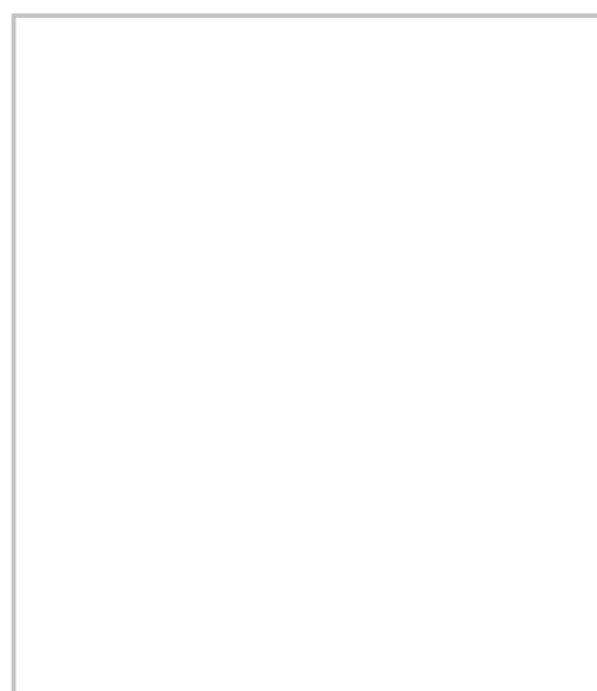

Scania in your region: EGYPT



Products

Trucks
Buses

After Sales

Service
Parts
Emergency

Contact Us

Head
Service Center
Request Form



TRUCK SERIES



Most common

As per our customer's needs in Egypt, there are some specifications that we recommend

P-series

The Scania P-series is our most versatile cab range, ideal for urban and regional operations and well-proven for construction and other demanding conditions

G-series

The Scania G-series range brings a distinctive combination of conform and elegance inside and out. Offering unique storage options as well as a spacious

R-series

The distinct R-cab is sturdier yet sharper than ever. Get ready to turn heads with the athletic body that redefines premium in long haulage.

S-series

The S-series raises the stakes in long-distance driver comfort. Discover an interior that's a haven of luxury, with a flat floor and extended storage facilities designed for

BUSES AND COACHES

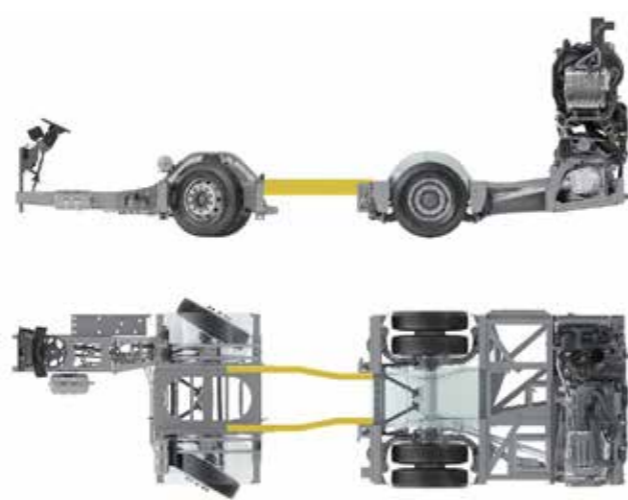

Scania in your region: EGYPT



Products

Trucks
Buses

After Sales

Service
Parts
Emergency

Contact Us

Head
Service Center
Request Form



P - SERIES

P - SERIES



OPTIMISED FOR URBAN AND REGIONAL TRANSPORT

With the P-series trucks you get a low weight cab with great visibility and driveability that is well balanced to suit your specific needs. The P-series is our most versatile cab range, ideal for urban and regional operations and well-proven for construction and other demanding conditions.

The P-series has excellent visibility and driveability, improving both safety and the feeling of control. The P-cab offers easy cab access, a quiet working environment and improved space and storage.

 <h3>DRIVER AREA</h3> <p>Urban Driving involves many starts and stops, repeated climbing in and out of the cab and the constant need to keep track of other vehicles and pedestrians around the truck while driving.</p>	 <h3>EXTRA SPACE</h3> <p>Working long hours like your drivers do, they might need to bring additional equipment, both personal and work-related. Either way, our cabs are equipped with smart storage facilities enabling them to stock up without the cab feeling cramped.</p>	 <h3>EXTERIOR DESIGN</h3> <p>Front, roof, side, underbody – all areas have been analysed, redesigned and optimised to achieve the lowest possible air drag. The shape of the cab and its corners, all gaps and angles have been narrowed and streamlined to achieve more efficient air flow and dynamic flow of lines. The lighting is one of the most prominent features of your truck, enhancing both its appearance and safety levels. As part of the basic configuration, position lights and extra lights are now integrated into the cab, without having a negative impact on aerodynamics.</p>
--	---	---

“WE ARE DEVELOPING SOLUTIONS TO ENSURE THAT OPERATORS IN THE WORLD’S MAJOR CITIES ARE ABLE TO COPE WITH THE CHALLENGES THAT FACE THEM.”

 <h3>P-SHORT</h3> <p>The short cab with low roof maximises the load capacity. Cab height 2920 mm (without air deflectors) Bed No Powertrain 250-460 HP</p>	 <h3>P-DAY</h3> <p>The lower roof allows for transport of overhead loads. Cab height Low (2920 mm), Normal (3260 mm) (without air deflectors) Bed No Powertrain 250-460 HP</p>	 <h3>P-SLEEPER</h3> <p>A day cab with resting equipment. Cab height Low (2920 mm), Normal (3260 mm), Highline (3520 mm) (without air deflectors) Bed Yes, 1 Bed Powertrain 250-460 HP</p>
---	---	--



P-SERIES SPECIFICATIONS

Scania delivers a wide range of engines which are compatible with alternative fuels, so you can find your perfect operational power to get the job done. This includes the new Scania Super 13-litre engine which contributes to groundbreaking powertrain fuel savings of 8%.

[See More >](#)

MAXIMISED COMFORT

Scania P-series is a premium working cab with easy access, incredible storage options and world-class resting possibilities. With an optimised dashboard and on-board entertainment, life on the road just got more comfortable. Our cabs and cab suspension have been designed to reduce vibrations to maximise the comfort. The driver seat and steering wheel can be adjusted to find your perfect driving position.

VISIBILITY

The Scania P-series is renowned for being handy in many different applications and operations. Entrance to the cab is low, with convenient handles that make it easy to climb in and out. The driver sits high and has a good view of the traffic ahead. It's the best driver station in its class.

FIND YOUR POWER

Scania delivers a wide range of engines which are compatible with alternative fuels, so you can find your perfect operational power to get the job done. This includes the new Scania Super 13-litre engine which contributes to groundbreaking powertrain fuel savings of 8%.

EURO 3

13-litre ▾

Output	Torque	Fuel	Emission Technology	Engine PTO
460 Hp	2250 Nm	Diesel/HVO/Biodiesel	Without SCR	600 Nm
410 Hp	2050 Nm	Diesel/HVO/Biodiesel	Without SCR	600 Nm
360 Hp	1800 Nm	Diesel/HVO/Biodiesel	Without SCR	600 Nm

9-litre ▶

GEARBOX ALTERNATIVES

Our comprehensive gearbox range can be adapted to all types of powertrain to deliver the full range of power across your Scania powertrain. Offering improved driveability, Scania's gearboxes can be fitted with the high-performance Scania Retarder.

The Scania Opticruise Mechanical Gearbox G25 and G33 set the highest industry standard for gearbox performance. Together with improved overall robustness, the Scania Opticruise remains the leading choice for sustainable, fuel-efficient transport operations.

RANGE-CHANGE GEARBOXES RANGE-SPLITTER GEARBOXES OPTICRUISE GEARBOX

Scania's Opticruise gearbox platform, available in two performance steps G25 and G33, delivers improved and speedy gearshifting in combination with excellent comfort and fuel savings of one percent.

The Opticruise's fully automated clutch control, which allows for precision manoeuvring and smoother gear performance, is complemented by a wider, more efficient 14-gear spread, and new technologies such as variable oil volume and oil spray function to improve gear lubrication and reduce internal losses.

The platform also introduces a new compact, geometric design, as well as low weight cast aluminium housing, resulting in significantly lower sound levels and a reduced component weight of up to 75 kilograms. Additionally, the Opticruise delivers increased uptime and fewer maintenance stops through an extended oil change interval. All this to ensure that your total operating economy is optimised.

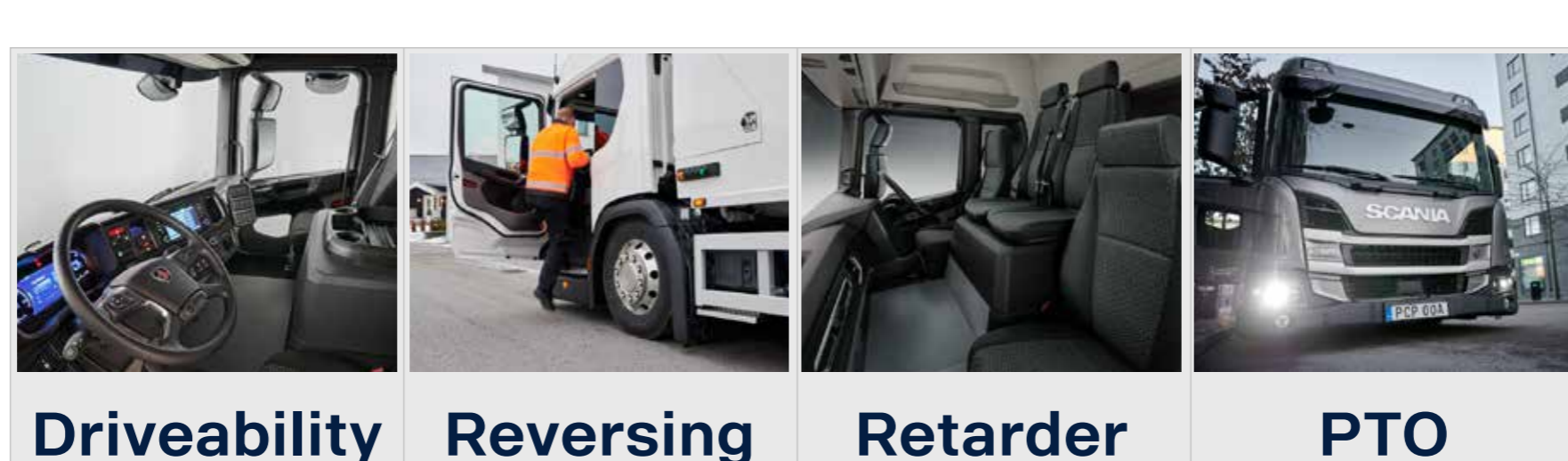

Driveability

Better driveability is achieved with a wider gear ratio spread, which includes super crawler and overdrive, that match Scania's low rev engine philosophy.

Reversing

Instead of a reversing gear, a planetary gear is used for reversing. This solution enables having eight gears for going in reverse at speeds up to 30 km/h. (This is useful when, for instance, tipper trucks need to reverse for long distances.)

Retarder

The retarder on the G33 has also been updated and improved and can now deliver 4700 Nm torque at a propeller shaft speed below 600 rpm.

PTO

PTO - With the Scania Opticruise gearbox, a new PTO programme with nine different performance steps is introduced. Higher torque and gear ratio improves the overall performance of bodywork equipment. Lower noise levels and reduced fuel consumption is the result of higher gear ratio, which allows lower engine speeds.

OUR RANGE

 <p>Most common</p> <p>As per our customer's needs in Egypt, there are some specifications that we recommend</p>	 <p>P-series</p> <p>The Scania P-series is our most versatile cab range, ideal for urban and regional operations and well-proven for construction and other demanding conditions</p>	 <p>G-series</p> <p>The Scania G-series range brings a distinctive combination of conform and elegance inside and out. Offering unique storage options as well as a spacious</p>	 <p>R-series</p> <p>The distinct R-cab is sturdier yet sharper than ever. Get ready to turn heads with the athletic body that redefines premium in long haulage.</p>	 <p>S-series</p> <p>The S-series raises the stakes in long-distance driver comfort. Discover an interior that's a haven of luxury, with a flat floor and extended storage facilities designed for</p>
--	--	--	--	---

Scania in your region: EGYPT

Products

Trucks
Buses

After Sales

Service
Parts
Emergency

Contact Us

Head
Service Center
Request Form



MOST COMMON

DIESEL

[DOWNLOAD HERE](#)

CNG

[DOWNLOAD HERE](#)

Scania in your region: EGYPT



Products

Trucks
Buses

After Sales

Service
Parts
Emergency

Contact Us

Head
Service Center
Request Form



BUSES AND COACHES

FOR EVERY MILE AND EACH JOURNEY

Scania aims to be a frontrunner in sustainable mobility. And we know that caring about the bigger picture requires putting a lot of effort into the details. Over more than a century, we have accumulated a deep understanding and a knowledge base that enables us to develop the buses, coaches, and services needed to make sustainable mobility happen – everywhere.

At Scania, we approach the challenge from all angles, providing a wide range of efficient quality vehicles and smart services that allow sustainability to go hand in hand with operating economy. That, we believe, is how we create real change.

COACHES



CITY BUSES

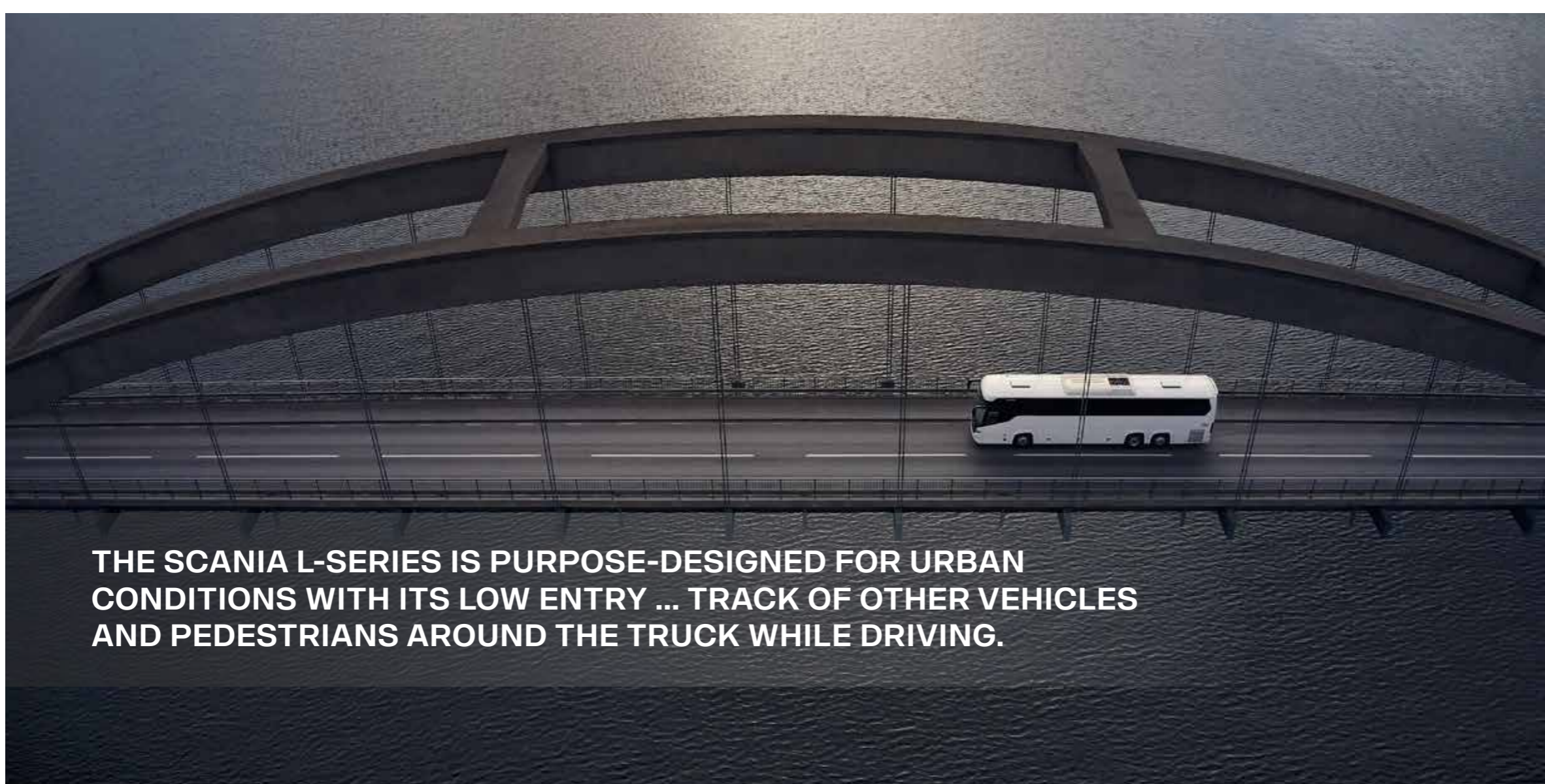

THE SCANIA L-SERIES IS PURPOSE-DESIGNED FOR URBAN CONDITIONS WITH ITS LOW ENTRY ... TRACK OF OTHER VEHICLES AND PEDESTRIANS AROUND THE TRUCK WHILE DRIVING.

Scania in your region: EGYPT



Products

Trucks
Buses

After Sales

Service
Parts
Emergency

Contact Us

Head
Service Center
Request Form



AFTER SALES

jhdsi khjoawijd oijasldj dsh khs safhali

SERVICE

Lorem ipsum dolor sit amet, consectetur adipiscing elit, sed diam nonummy nibh euismod tincidunt ut laoreet dolore magna aliquam erat volutpat. Ut wisi enim ad minim veniam, quis nostrud exerci tation ullamcorper suscipit lobortis



Service Center

Industrial Zone #3,
Daewoo St, Parcel 148,
6 October City
Tel. (+202) 3820 4093
Fax (+202) 3820 4092
Mobile (+2) 0122 0000 655



SERVICE OFFERING

EMERGENCY 24/7

- We are providing 24/7 emergency assistance.
- We are extending our help to our customers at all times.

[See More >](#)

FIELD SERVICE

- In order to maximize customer uptime and also efficiency we perform service and repairs at customer site.

[See More >](#)

NON-STOP REPAIRS

- Finishing required repairs without stopping with high quality.
- Customer can receive his

[See More >](#)

REPAIR AND MAINTENANCE CONTRACTS

- At Scania we work together to make sure that wherever you are, whatever happens you can rely on us.

[See More >](#)

FIXED PRICES CAMPAIGNS

- Scania fixed prices campaigns are competitive packages including all parts, labor, and consumables.

[See More >](#)



SCANIA PARTS

We engineer our parts for ultimate performance, endurance, fuel economy and safety. Our experts will identify and organise the items you need quickly. And our global logistics network ensures that all Scania parts are available for rapid delivery.



for all parts

[DOWNLOAD HERE](#)

Main Branch for Spare Parts

11 Aghakhan Buildings,
Dawletian St, Corniche El Nile,
Khalafawy, Shobra
(+202) 2205 1774 - (+2) 0122 4576 969



Autoparts Branches

Chillout Alamriya, Alex

Chillout gas station, Merghem
Alamriya, Alexandria
(+2) 012 7344 4735



Sakr Koresh - Maadi

New Maady, Autostrad road,
alamal towers, building no 93
(+2) 012 7344 4741



Tiba Mall - October

Tiba Grand Mall, Laylat
Al Qadr Square, 6 october
(+2) 012 7344 4732



THE SCANIA L-SERIES IS PURPOSE-DESIGNED FOR URBAN CONDITIONS WITH ITS LOW ENTRY ... TRACK OF OTHER VEHICLES AND PEDESTRIANS AROUND THE TRUCK WHILE DRIVING.

Scania in your region: EGYPT



Products

Trucks
Buses

After Sales

Service
Parts
Emergency

Contact Us

Head
Service Center
Request Form



CONTACT US

Please contact us if you have any questions about our products, services or other activities within Scania Egypt.

SUBMIT YOUR REQUEST

First name

Last name

Email

Phone number

Your message

We respect your privacy and will never sell your information. We will deal with your information in accordance with our Privacy Notice.

Please Select

Limited company/partnership or PLC Private individual or sole trader

I agree to the terms & conditions

SUBMIT

OR CONTACT US DIRECTLY

Headquarter

Twin Towers Building A 2nd floor,
Sheikh Zayed, Giza 12461, Egypt
(+202) 3796 3757 - (+2) 0100 0000 000

Spare Parts Branch

11 Aghakhan Buildings, Dawletian St,
Corniche El Nile, Khalafawy, Shobra
(+202) 2205 1774 - (+2) 0122 4576 969

Service Center

Industrial Zone #3, Daewoo St, Parcel 148,
6 October City
(+202) 3820 4093 - (+2) 0122 0000 655

→ FIND US

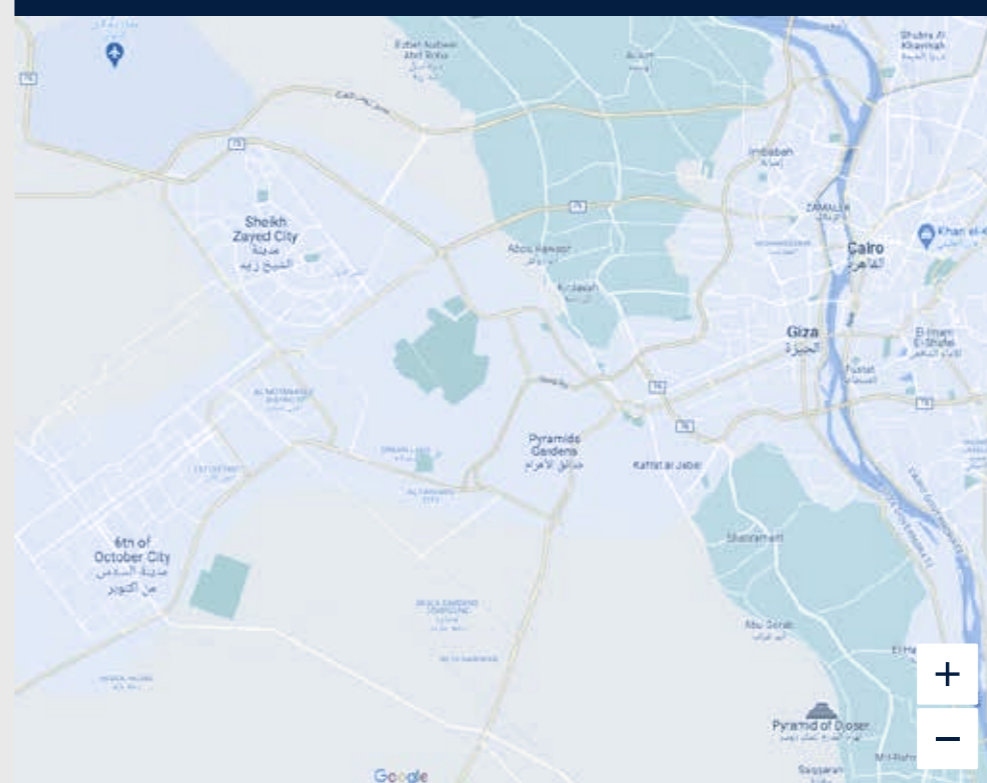

Scania in your region: EGYPT



Products

Trucks
Buses

After Sales

Service
Parts
Emergency

Contact Us

Head
Service Center
Request Form